

Data Sheet



Article number: 20990NID201000BL

Description: E+G GN 990 Construction tube round
GN 990-NI-D20-1000-BL

Measures

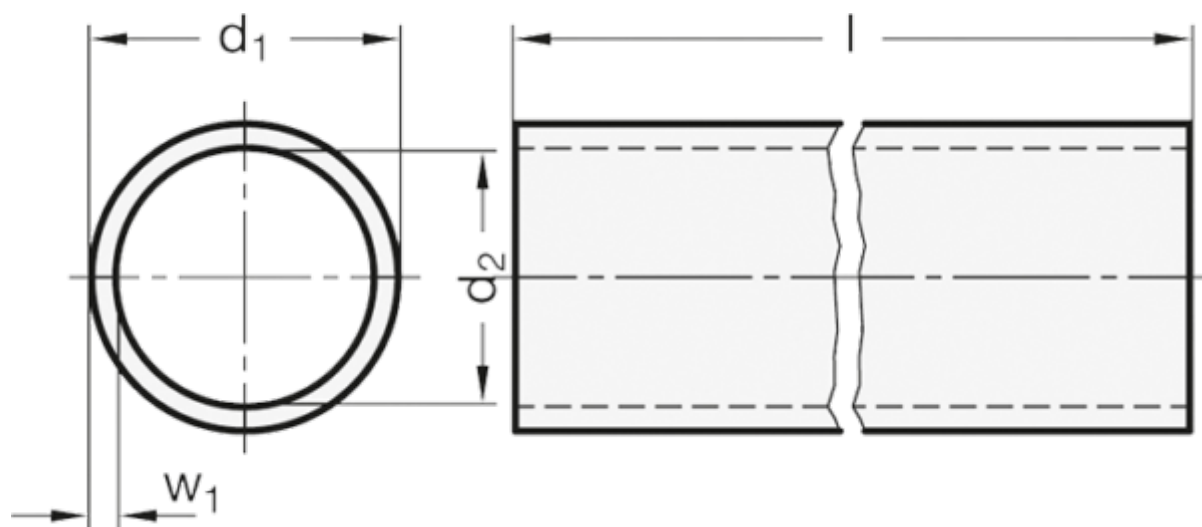

d_1 = D20-0.2

d_2 = 16

$l \pm 0.5$ = 1000

w_1 = 2

Weight in (g) = 750